

User Manual

Binocular Compound LED Microscope

Model M827TL Series



MicroscopeNet.com

Table of Contents

i. Caution	1
ii. Care and Maintenance.....	2
2 Components Illustration	3
3 Installation	4
4 Operation.....	6
5 Specifications	10
6 Optional Parts.....	11
7 Troubleshooting Guide	13
8 Darkfield Condenser Installation and Operation Instructions.....	15

i. Caution

1. Open the carton carefully with a knife or paper cutter. Find the “UP” sign and place the Styrofoam container on the side that makes the arrow upward. If the “UP” sign is missing, please open the Styrofoam container gently to prevent any accessory, i.e. objectives or eyepieces, from dropping and being damaged.
2. Do not discard the molded Styrofoam container. The container should be retained should the microscope ever requires reshipment.
3. Keep the instrument out of direct sunlight, high temperature or humidity, and dusty environments. Ensure that the microscope is located on a smooth, level and firm surface.
4. If any specimen solutions or other liquids splash onto the stage, objective or any other component, disconnect the power cord immediately and wipe up the spillage. Otherwise, the instrument may be damaged.
5. All electrical connectors (power cord) should be inserted into an electrical surge suppressor to prevent damage due to voltage fluctuations.
6. Confirm that the input voltage indicated on your microscope corresponds to your line voltage. The use of a different input voltage other than that as indicated will cause severe damage to the microscope.

ii. Care and Maintenance

1. Do not attempt to disassemble any component including eyepieces, objectives or focusing assembly.
2. Keep the instrument clean; remove dirt and debris regularly. Accumulated dirt on metal surfaces should be cleaned with a damp cloth. More persistent dirt should be removed using a mild soap solution. **Do not use organic solvents for cleansing.**
3. The outer surface of the optics should be inspected and cleaned periodically using an air stream from an air bulb. If dirt remains on the optical surface, use a soft cloth or cotton swab dampened with a lens cleaning solution (available at camera stores). All optical lenses should be swabbed using a circular motion. A small amount of absorbent cotton wound on the end of a tapered stick makes a useful tool for cleaning recessed optical surfaces. Avoid using an excessive amount of solvents as this may cause problems with optical coatings or cemented optics or the flowing solvent may pick up grease making cleaning more difficult. Oil immersion objectives should be cleaned immediately after use by removing the oil with lens tissue or a clean, soft cloth.
4. Observe the specimen with the 4X, 10X and 40X objectives in order, then observe the specimen with the 100X objective. Apply the immersion oil on the slide cover with the 100X objective. Do not let the immersion oil to contact with the dry objectives lens (especially the 40X). Clean the dry objective lens using the camera cleaning kit if the immersion oil is on the dry objectives lens. Clean the 100X objective lens first using the camera cleaning kit after observing the specimen with the 100X objective, then clean the specimen. More persistent dirt should be removed using a little bit alcohol. **Do not use organic solvents for cleansing.**
5. Store the instrument in a cool, dry environment. Cover the microscope with the dust cover when not in use.

1 Components Illustration

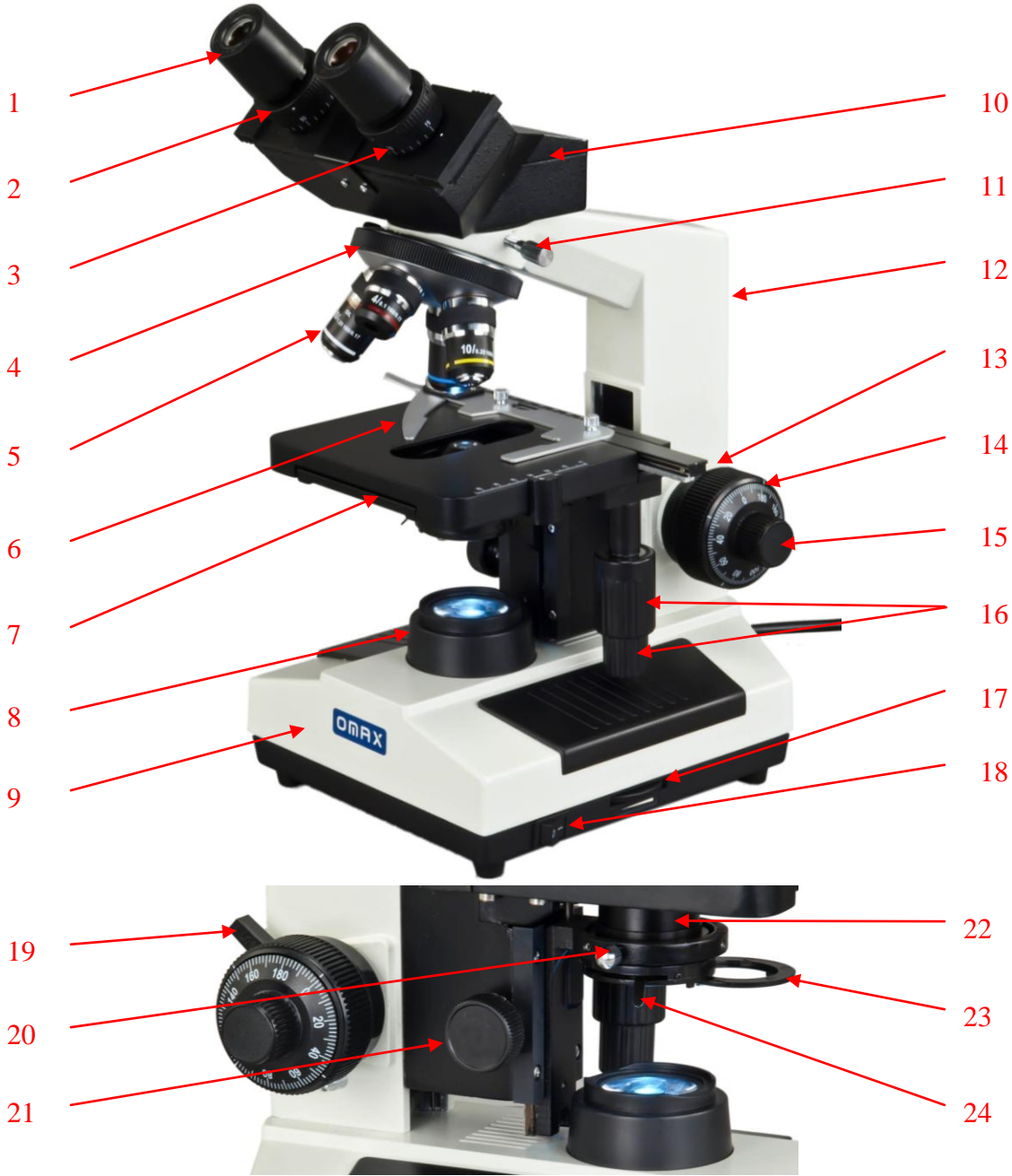

1	19	9	20	17
2	20	10	21	18
3	21	11	22	19
4		12	23	20
5		13	24	21
6		14		22
7		15		23
8		16		24

2 Installation

2.1 Installation of the binocular viewing head

- 1) Loosen the head thumb lock screw on the top of the microscope body and remove the plastic cover on the top.
- 2) Remove the cap on the dovetail of the binocular viewing head.
- 3) Seat the dovetail completely of the viewing head into the socket on the top of the microscope body and tighten the head thumb lock screw.

Caution:

Do not release the viewing head from your hand grip until you are sure the viewing head is installed securely.

2.2 Installation of the eyepieces

- 1) Remove the protective caps from the eyepiece tubes.
- 2) Insert the eyepieces into the eyepiece tubes.

2.3 Installation of the objectives

- 1) Adjust the coarse focus knob until the mechanical stage is at its lowest position.
- 2) Turn the caps counter-clockwise to remove them from the nosepiece.
- 3) Take the objectives out from the plastic cases and turn each one clock-wise into the holes on the nosepiece. Install the 4X objective into the nosepiece first. Then in a counter-clockwise direction, rotate the nosepiece and install each succeeding higher magnification objective as shown in **Fig. 1**.

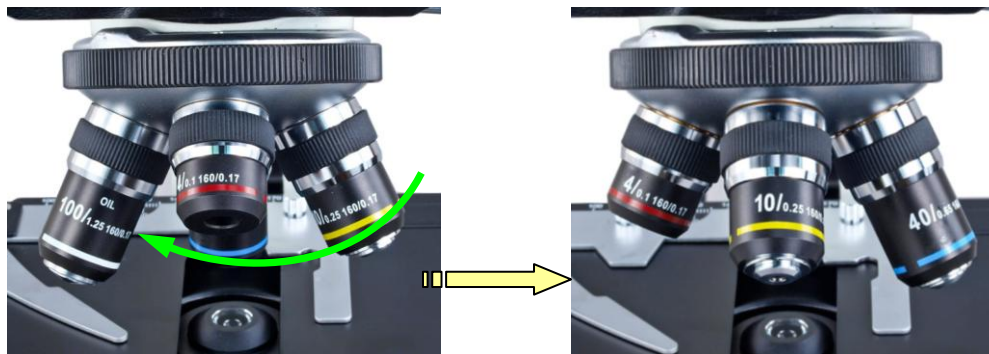

Fig.1

Note:

- Inspect the objectives frequently for dirt or oil; clean if necessary.
- Use the 10X objective to initially focus the image of your specimen.
- When changing the objective magnification, rotate the objective nosepiece until you hear a “click” sound or have a clear “in position” feeling. This ensures the objective is centered in the optical light path.

2.4 Installation of the glass filter

- 1) Swing out the color filter holder under the condenser.
- 2) Place the filter into the holder as shown in **Fig. 2**, swing the holder in.

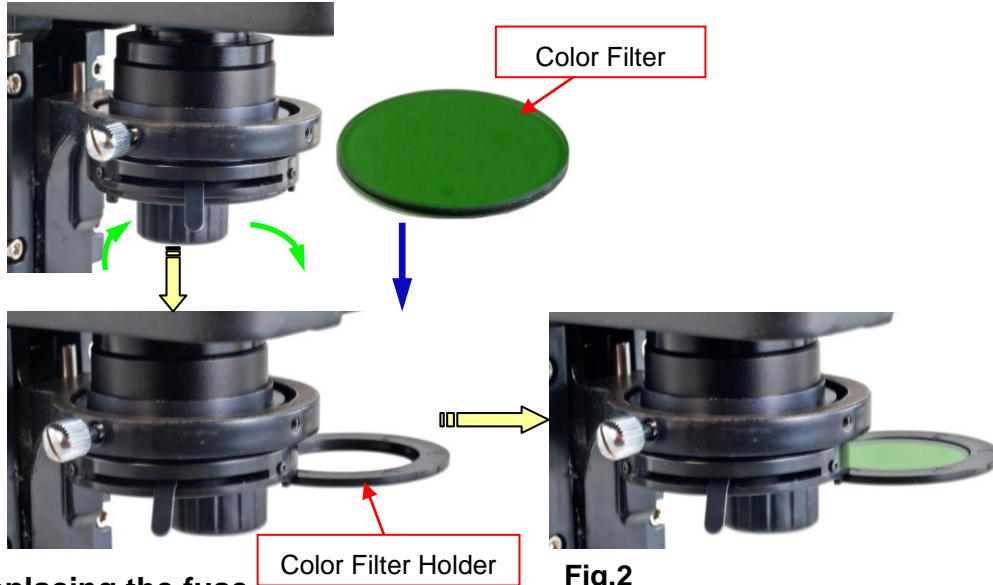

Fig.2

2.5 Replacing the fuse

- 1) Turn off the power switch and disconnect the power cord.
- 2) Turn over the microscope on its side; find the fuse holder at the bottom of the base.
- 3) Turn the fuse holder counter-clockwise to take it off, replace the fuse, and then turn it on clockwise. See **Fig. 3**.

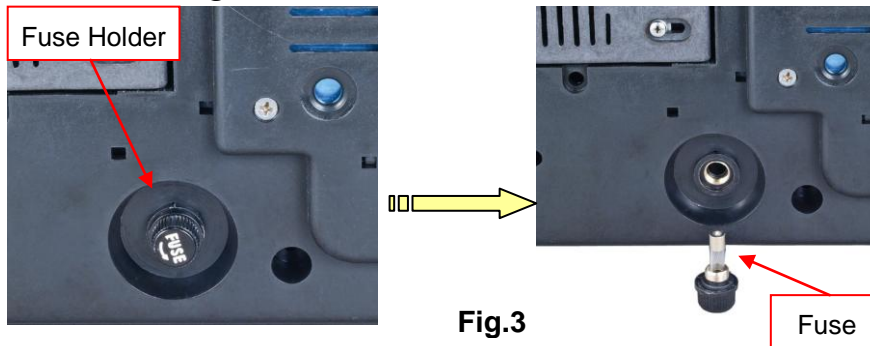

Fig.3

Caution:

Before you turn over the microscope, be sure to take the eyepieces off and be certain that the head is securely locked by the thumb screw.

2.6 Installing the mirror (optional, may not included in your package)

- 1) Turn off the power switch and disconnect the power cord.
- 2) Screw off the light collector on the microscope base.
- 3) Screw the black disc onto the base and then insert the mirror into the hole at the center of the black disc. See **Fig. 4**. You may try to get reflected ambient light on either side of the mirror with different angles for best result.



Fig.4

Note:

The mirror is only used when there is a power failure or you are in the field and no power is available.

2.7 Installation of the camera (optional, may not included in your package)

- 1) Take off the eyepiece from the eyepiece tube.
- 2) Insert the camera into the eyepiece tube, and then connect the camera to a computer via USB2.0 cable. See **Fig.5**.
- 3) The manual for the camera is on a CD (or mini CD). Refer to the manual to install the driver and software on to the computer.
- 4) The camera is optional and may have different color and shape from the one in the figure, depending on the model purchased.

**Fig.5****2.8 Installation of the darkfield condensers (optional, may not included in your package)**

Please see section 7 (*Darkfield Condenser Installation and Operation Instructions*)

3 Operation

3.1 Adjusting illumination

- 1) Plug the power cord into the power socket on the microscope and connect it to the power outlet.
- 2) Turn on the power switch.
- 3) Rotate the brightness intensity dial to increase or decrease the brightness.

Caution:

A diffusion filter is attached beneath the condenser to get uniform light and protect your eyes from strong light when a low power objective applied. The diffusion filter can be swung out to make the view field brighter when observing with a high power objective, such as 100X objective.

3.2 Placing specimen

- 1) Place the slide on the mechanical stage.
- 2) Use the slide holder to gently secure the slide.
- 3) Turn the X and Y stage moving knobs to position the specimen in the center of viewing field.

Caution:

Be sure not to allow an objective to touch a specimen slide when changing objectives.

3.3 Adjusting interpupillary distance

While observing with both eyes, hold the left and right eyepiece tubes then slide the tubes in and out. The interpupillary distance is correct when the left and right fields of view converge completely into one image.

3.4 Adjusting eyepiece diopter

- 1) Rotate the 10X objective into position.
- 2) Rotate the diopter rings on the eyepiece tubes until its numerical value is the same as your interpupillary distance, for example, **70** in the figure (See **Fig. 6**).
- 3) Close your left eye and bring the specimen into focus following the focusing procedures in **3.5**.
- 4) Close your right eye and bring the same specimen into clear sharp focus by adjusting the diopter ring on left eyepiece tube only. Do not use focus knobs at this step.
- 5) Since both sides are adjustable, you may also do the above in the opposite way, in other words, left eye first and right eye second.

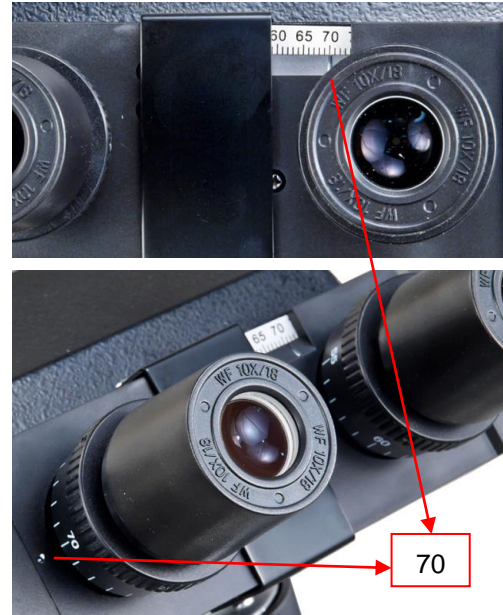

Fig.6

3.5 Focusing

- 1) With the 10X objective in position, raise the mechanical stage using the coarse focus knob until the specimen is close to the objective.
- 2) Turn the coarse focus knob until the specimen is in focus.
- 3) Use the fine focus knob to obtain a sharp image.
- 4) To get a good focused image, you may need to combine the focus knob adjustment and interpupillary distance adjustment, along with eyepiece diopter adjustment stated in **3.3** and **3.4**.
- 5) You may now switch to another magnification objective.

Tips:

To prevent your specimen slide from making contact with an objective, raise the stage to its highest position without contacting the 100X objective, then tighten the focus stop lever (**Fig. 7**). Give the stage a tiny extra moving space to ensure the objective can be focused every time.



Fig.7

3.6 Applying the immersion oil

- 1) Rotate the objective nosepiece to seat the observing position between the 40X and 100X objectives as shown in **Fig. 8 (a)**.
- 2) Place a drop of immersion oil on the slide cover as shown in **Fig. 8 (b)**.
- 3) Rotate the objective nosepiece to seat the 100X objective to the observing position until you hear a “click” sound.
- 4) After observing the specimen, use the camera cleaning kit to clean the 100X objective lens gently and the specimen in time.
- 5) If it is hard to clean, you need a little bit alcohol to clean the 100X objective lens and the specimen.

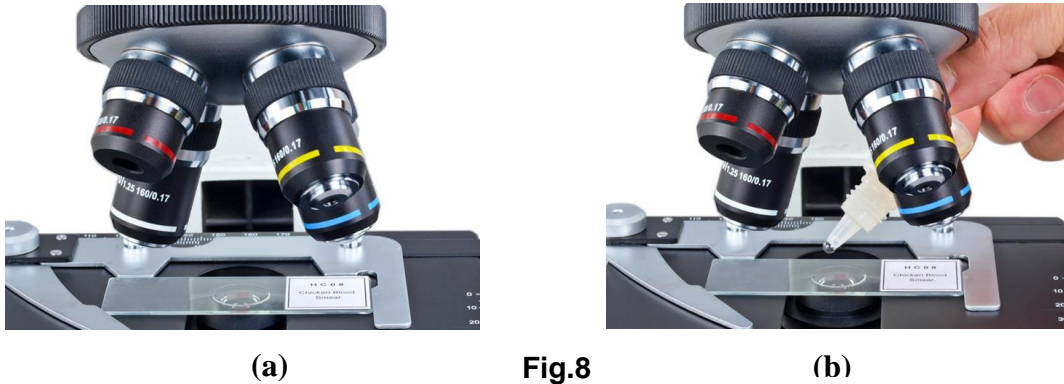

(a)

Fig.8

(b)

Caution (important):

- When you use the 100X objective to observe the specimen, you have to finish observing the specimen with the 4X, 10X, 40X objectives.
- When you use the 100X objective to observe the specimen, you have to apply the immersion oil on the top of the slide cover.
- When you apply the immersion oil with the 100X objective, do not let the immersion oil to contact with the dry objective lenses (especially the 40X). If the immersion oil is on the dry objectives lens, please use the camera cleaning kit to clean the objectives lens in time. The oil will damage the dry objective lenses.
- After observing the specimen with the 100X objective, clean the 100X objective lens first.

3.7 Adjusting condenser

- 1) Turn the condenser focus knob to raise or lower the condenser.
- 2) Raise the condenser when using high power objectives and lower it when using low power objectives.

Note:

- The centering of the condenser and the light axis of the objective are factory adjusted. Do not attempt to re-adjust.
- The highest position of the condenser has been factory adjusted. Do not attempt to re-adjust.

3.8 Adjusting iris aperture diaphragm

Swing the iris diaphragm lever (**Fig. 9**) left or right to adjust the aperture size.

Note:

The iris diaphragm is designed to adjust the aperture size, not to adjust the brightness although the brightness will be changed when it's adjusted. When aperture is adjusted to smaller size, the contrast will be increased and the depth of field will be increased as well. Turn up the intensity of the light if the image is too dim.

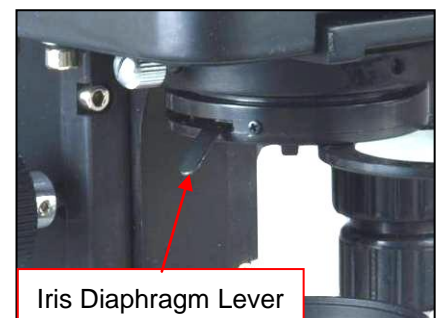

Fig.9

3.9 Adjusting focus tension

The focus tension has been pre-set at the factory. If the mechanical stage drops by itself, rotate the tension adjustment ring (**Fig. 10**) situated between the coarse focus knob and microscope body on the power switch side until the tension is maintained.

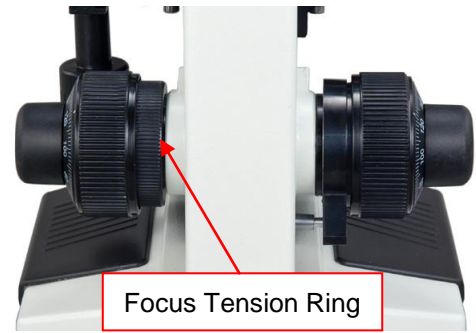

Fig.10

3.10 Camera (*optional, may not included in your package*)

- 1) Bring the microscope into focus by following the procedures in **3.5**.
- 2) Install the camera by following the procedures in **2.7**.
- 3) Open image observing software to examine (more details see camera's manual).
- 4) You also can capture images or record live videos through the software, depending on the functions provided by the software.

Note:

Please refer to the manuals in the camera's CD for the details of installation and operation of the camera.

3.11 Darkfield condensers observation (*optional, may not included in your package*)

Please see section 7 (*Darkfield Condenser Installation and Operation Instructions*)

4 Specifications

Model	M827TL series
Total Magnification	40X, 64X, 100X, 160X, 400X, 640X, 1000X, 1600X
Viewing Head	Binocular, 45° inclined, 360° swiveling
Interpupillary Distance	Sliding adjustment, 2-3/16" ~ 2-15/16" (55mm~75mm)
Diopter Adjustment	On both eyepiece tubes
Eyepieces	1 pair of WF10X/18 1 pair of WF16X
Objective Tube Length	160mm
Nosepiece	Revolving quadruple
Objectives	Achromatic DIN 4X, 10X, 40X(spring), 100X(spring, oil)
Condenser	Abbe, NA=1.25, with iris diaphragm and filter holder Rack and pinion adjustment
Focus Mechanism	Coaxial coarse and fine focusing knobs on both sides with focus stop Minimum fine focusing adjustment at 0.002mm, range 28mm
Mechanical Stage	Double layer, dimension: 5-1/2" x 5-1/2" (140mm x 140mm) Translational range: 3" x 2" (75mm x 50mm)
Cameras (<i>optional</i>)	Refer to the cameras specifications
Darkfield Condensers (<i>optional</i>)	Refer to the darkfield condensers specifications
Carrying Case (<i>optional</i>)	Refer to the carrying case specifications
Illumination	Transmitted, replaceable 3W LED light, variable intensity
Power Supply	AC 100V-240V, 50/60HZ (US and Canada plug)
Dimension	7-7/8" x 10-1/4" x 15-3/8" (20cm x 26cm x 39 cm)
Net weight	10 lb (4.5 kg)



5 Optional Parts

(The optional parts may be included in some models or sold separately.)



1) Cameras

	Model	Resolution	Operating System	Software
	A1502	640 x 480 (0.3MP)	MS Windows Mac OS X 10.6-10.8	Included
	A3513U	1280 x 1024 (1.3MP)	MS Windows Mac OS 10.8 and up Linux (2.6 or above)	
	A3520U	1600 x 1200 (2.0MP)		
	A3530U	2048 x 1536 (3.0MP)		
	A3550U	2592 x 1944 (5.0MP)		
	A3590U	3488x2616 (9.0MP)		

2) Darkfield Condensers

	Model	Darkfield Condenser	Numerical Aperture	Objective	Mounting Size(diameter)
	A191	Dry	0.7-0.9	-	37mm
	A191BD	Oil	1.36-1.25	-	37mm
	A191BOIL	Oil	1.36-1.25	Plan 100X/1.25 oil-0.5 160/0.17(spring), w/ iris diaphragm	37mm

3) Carrying Case

	Model	Dimension	Net Weight
	A187V	9-7/8" x 11" x 18-1/2" (25cm x 28cm x 47cm)	2 lb 6 oz (1.1 kg)
	A185A	18-1/8" x 13" x 13-3/8" 46cm x 33cm x 34cm	10 lb 14 oz (4.93 kg)

6 Troubleshooting Guide

GENERAL PROBLEMS

Problem	Cause	Solution
Lamp does not light when switched on	No electrical power	Check power cord connection
	LED or power unit dead	Replace LED light
	Fuse blown out	Replace fuse
Darkness at the periphery or uneven brightness in the field of view	Revolving nosepiece not in click stop position	Revolve the nosepiece to click-stop position by swinging the objective correctly into the optical path
	The light source of the lamp is not at the center	Adjust the position of the lamp
Dirt or dust on the view	Dirt or dust on the lens eyepiece, condenser, objective, collector lens or specimen	Clean the lens with a camera cleaning kit
Poor image quality or not able to get focused image	No slide cover attached to the slide	Attach a 0.17mm slide cover
	Slide cover is too thick or thin	Use a slide cover of the appropriate thickness (0.17mm)
	Slide may be upside down (specimen at the bottom)	Turn slide over so the cover-glass faces up
	Diopter adjustment is not set properly	Readjust the diopter settings
	Immersion oil is on a dry objective (especially the 40X)	Check the objectives, clean if necessary
	No immersion oil used with 100X objective	Use immersion oil
	Air bubbles in immersion oil	Remove bubbles
	Condenser aperture is closed or open too much	Open or close properly
	Condenser is positioned too low	Position the condenser upward
	Specimen rises from stage surface	Secure the specimen in the slide holder
	Blue filter not used	Use daylight blue filter
	Lamp intensity is too high or low	Adjust the light intensity by rotating the intensity control dial
Slippage of focus when using the coarse focusing knob Fine focus is ineffective	Tension adjustment is set too low	Increase the tension on the focusing knobs
	Tension adjustment is set too high	Loosen the tension on the focusing knobs

DARKFIELD PROBLEMS

Problem	Cause	Solution
It's totally dark in the viewing field	The light is not on	Turn on the light
	<i>(A191BOIL, A191BD only)</i> There is no oil in between the condenser top lens and slide	Place a drop of oil on the top lens of condenser and let it contact the underside of slide
	<i>(A191BOIL only)</i> The built-in iris diaphragm of 100X objective is not in proper position	Adjust the iris diaphragm ring on the objective
	The condenser is not in the right position	Lower or raise the condenser slightly to the position that the specimen is the brightest. <i>(A191BOIL, A191BD only)</i> Make sure the oil contact the bottom of the slide and the top of the condenser during the adjustment.
The illumination is insufficient or too bright	The intensity of lamp is too low	Adjust the intensity dial to increase the brightness
	The condenser is not in the right position	Lower or raise the condenser slightly to the position that the specimen is the brightest. <i>(A191BOIL, A191BD only)</i> Make sure the oil contact the bottom of the slide and the top of the condenser during the adjustment.
	The condenser is not centered properly	Adjust the translational centering screws to center the condenser
	<i>(A191BOIL only)</i> The built-in iris diaphragm of 100X objective is not in proper position	Turn the iris diaphragm ring on the objective
Image of the specimen is not clear and lacking in sufficient contrast	The specimen is not suitable for darkfield observation	Change to brightfield or phase contrast
	<i>(A191BOIL only)</i> The built-in iris diaphragm of 100X objective is not in proper position	Turn the iris diaphragm ring on the objective
	The condenser is not in the right position	Lower or raise the condenser slightly to the position that the specimen is the brightest. <i>(A191BOIL, A191BD only)</i> Make sure the oil contact the bottom of the slide and the top of the condenser during the adjustment.

7 Darkfield Condenser Installation and Operation Instructions

7.1 Dry darkfield condenser of A191

- 1) Mounting the dry darkfield condenser
 - Loosen the condenser lock thumb screw on the condenser holder and remove the brightfield condenser.
 - Install the dry darkfield condenser and tighten the condenser lock thumb screw on the condenser holder (see **Fig. 11**).
- 2) Centering the dry darkfield condenser
 - Turn the 4X objective to the light path.
 - Turn the condenser focus knob to lower the condenser till a dark spot showed in the viewing field as shown in **Fig. 12 (a)**.
 - Turn the condenser translational centering screws to move the dark spot to the center as shown in **Fig. 12 (b)**.
- 3) Place the slide on the stage.
- 4) Raise the condenser all the way to the top and lower it a little bit.
- 5) Following the procedures in this manual to focus and observe.
- 6) Move the condenser up or down slightly to get the best darkfield viewing.

Note:

- The dry darkfield condenser is used with the dry objectives only.
- The dry darkfield condenser works with the 4X, 10X, 40X objectives.
- The dry darkfield condenser won't work with the 100X oil immersion objective.

7.2 Oil darkfield condenser of A191BD, A191BOIL

- 1) Mounting the oil darkfield condensers
 - Loosen the condenser lock thumb screw on the condenser holder and remove the brightfield condenser.
 - Install the oil darkfield condensers and tighten the condenser lock thumb screw on the condenser holder (see **Fig. 13**).
- 2) Centering the oil darkfield condensers
 - Turn the 40X objective to the light path.
 - Turn the condenser focus knob to slowly lower and raise the condenser till a dark spot showed in the viewing field as shown in **Fig. 14 (a)**.
 - Turn the condenser translational centering screws to move the dark spot to the center as shown in **Fig. 14 (b)**.

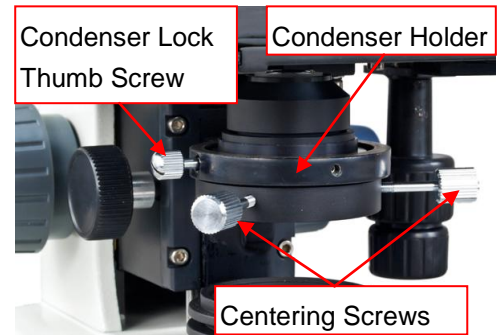

Fig.11

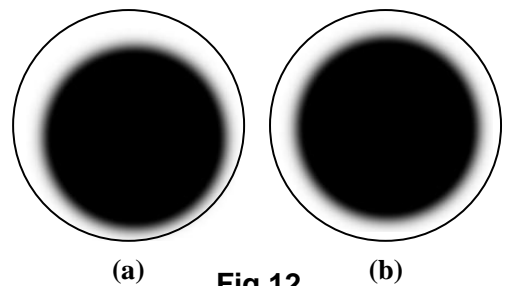

Fig.12

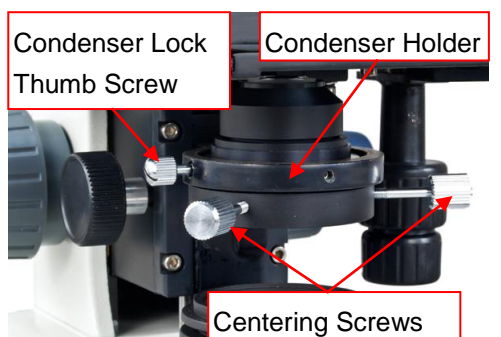

Fig.13

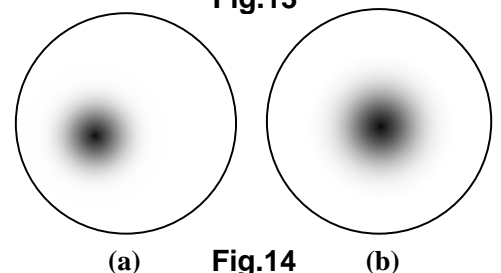

Fig.14

- 3) When using the 40X objective to observe the specimen
 - Place the slide on the stage.
 - Lower the condenser until a sharp brightfield image showing in the viewing field.
 - Raise the condenser until the darkfield image showing in the viewing field.
- 4) When using the 100X objective to observe the specimen
 - Raise the condenser until the top is close to the opening of stage.
 - Place a drop of immersion oil on the top of condenser.
 - Place the slide on the stage.
- 5) Raise the condenser and let the oil drop contact the bottom of the slide. If air bubbles exist in the oil, clean the oil from the top of the condenser and bottom of slide with a lens cleaning paper and repeat the procedures.
- 6) Follow the procedures in this manual to bring the sample on slide in focus and observe.
- 7) (**A191BOIL Only**) When using the 100X oil darkfield objective, you will need to drop the immersion oil and adjust the iris ring (**Fig. 15**) to get proper brightness and contrast of view field.
- 8) After observing the specimen with 100X objective, use the lens cleaning paper to gently clean the 100X objective lens, oil darkfield condenser and the specimen in time.
- 9) If it is hard to clean, you need a little bit alcohol to clean the 100X objective lens, oil darkfield condenser and the specimen.



Fig.15

Note:

- When using the 40X objective, you won't need to apply oil drop on the oil condenser.
- When using the 100X objective, the condenser won't work well if no oil drop applied on the condenser.
- When you apply the immersion oil with the 100X objective, do not let the immersion oil to contact with the dry objective lenses (especially the 40X). If the immersion oil is on the dry objectives lens, please use the lens cleaning paper to clean the objectives lens in time. The oil will damage the dry objective lenses.
- After observing the specimen with the 100X objective, clean the 100X objective lens first.